

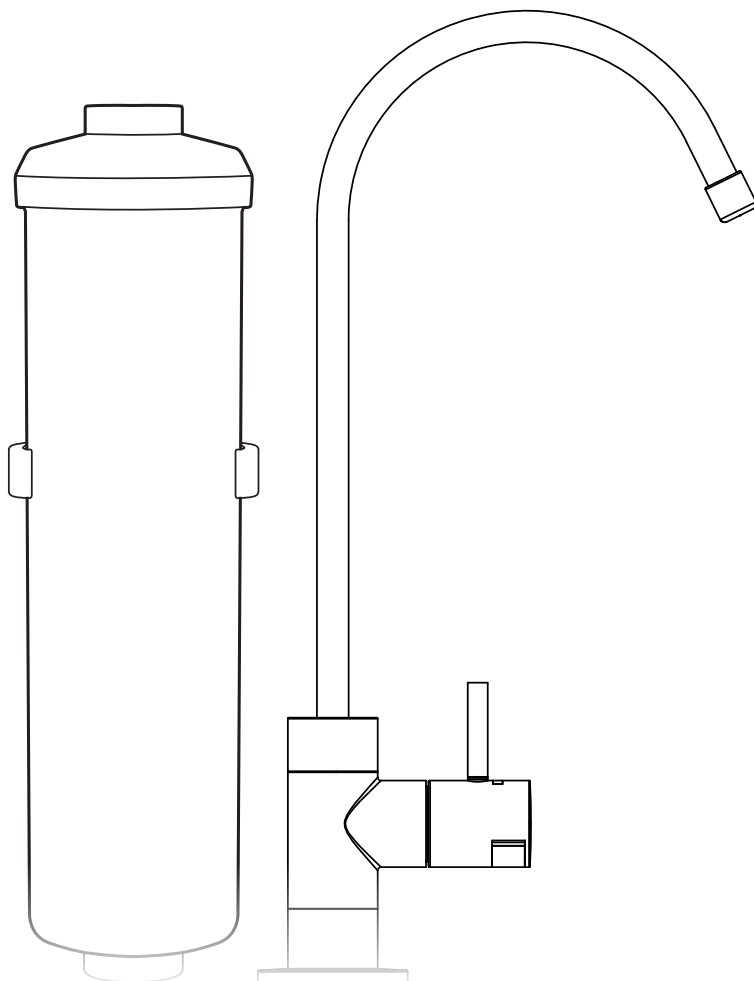

X3/X4

Inline Undersink Water Filtration System User Guide



What's inside

Puretec Customer Service 3

Operation 3

Cartridge Replacement..... 3

Installation Notes..... 3

Installation Requirements 4

Installation Procedure..... 4

Cartridge Installation/Replacement..... 4

Use Guidelines 5

Assembly Diagrams..... 6

Battery Installation..... 8

Warranty..... 9



WARNING!

This product contains a button battery. Accidental ingestion may occur and can be fatal. Please keep out of reach from infants. If you suspect an accidental ingestion please contact emergency services.



ATTENTION: For Australasian Consumers the LED filter change reminder light on this tap has been disabled/ removed in order to comply with new Legislation "Consumer Goods (Products Containing Button/Coin Batteries) Safety Standard 2020 - F2020L01658" This does not affect the performance of the filter system in any way and you are eligible for Puretec's free email cartridge reminder service.



WaterMark

AS 3497

Licence No. WM 74617
Pro-Switch Pty Ltd

Puretec Customer Service

Thank you for purchasing a Puretec inline undersink water filter system. Your system is a proven performer manufactured from only quality materials and components and will give years of 'spring fresh' water free of impurities if maintained properly.

The Puretec system cartridges need replacing regularly to maintain optimum performance. This is a simple procedure when following instructions. For cartridge replacements contact your nearest Puretec stockist.

Customer Service Helpline **1300 140 140** (Australia) **0800 130 140** (New Zealand).

Operation

The Puretec inline undersink water filter systems are designed to run economically for many years and this is dependant on the initial installation and periodical maintenance.

Flush systems for 10 minutes after any period of non-use more than 2 days. For a period of non-use of 2 weeks or more, it may be necessary to replace cartridge.

Cartridge Replacement

To maintain the high quality of the purified water the cartridges need changing every 6 - 12 months, dependent on water quality and usage.

When replacing cartridge, ensure you reset the LED reminder light by removing/replacing the battery from the rubber seat. Please refer to page 6 for a detailed diagram.

Replacement cartridge code for **X3** model : Puretec **IL149Q** and **X4** model : Puretec **IL150Q**

Installation Notes

This system comes complete with an installation kit enabling it to be connected to 15 mm (½") male thread.

Installation Note: A water filter system/tap, like any product, has a limited life and may eventually fail. Also sometimes failure happens early due to unforeseen circumstances. To avoid possible property damage, this product should be regularly examined for leakage and/or deterioration and replaced when necessary. A drain pan, plumbed to an appropriate drain or outfitted with a leak detector, should be used in those applications where any leakage could cause property damage, and/or the water supply should be turned off if no one is home/present.

Installation Requirements

- 1 15mm (½") Cold water line - mains only.
- 2 Supply pressure: 100 - 520 kPa.
- 3 Supply temperature 0° - 38°C.
- 4 Suitable location for faucet.

Alternative fittings may be required if being connected to anything other than 15 mm (½") copper pipe. No electrical or drainage requirements needed.

Installation Procedure

1. Select suitable location that is close to the point of filtered water delivery (eg. sink). Remember to allow access room for changing filters and a suitable place where water spillage will not cause damage. Location should not be in direct sunlight.
2. Isolate water supply and cut copper pipe ready to install the adaptor ballvalve.
3. Connect the SmartTee™ to the multivalve with a piece of white tubing (see figures 1-3).
4. Choose the best position for the faucet, taking into consideration height of jugs etc. and also the drainage of any spills. Then drill a Ø12.5mm hole and install the faucet as in step 5.
5. To install faucet, place the Escutcheon, O-Ring, Base Upholder into the Faucet (see figure 3). Insert the Faucet into the hole in sink or bench. Slip the large Plastic Washer and lock Washer onto threaded end of faucet and screw on Nut and tighten making sure Faucet is correctly positioned on top.
6. Reset LED indicator by following instructions on page 6.
7. Install filter cartridge by positioning it in the desired location, marking the position of fixing hole and fixing with bracket screw (Puretec inline cartridge can be mounted horizontally or vertically). Allow room for the connecting tubes. Ensure flow arrow on cartridge is in direction of water flow.
8. Fit tubing into connectors (quick-connect fittings see Fig 2). Allow slack in the tubing.
9. Restore the water supply and check for leaks.
10. Run the system for at least 5 minutes to remove carbon fines. Water may appear milky, but this is normal and is only tiny air bubbles that will clear after a short period.

Cartridge Installation/Replacement

1. Place container under filter in case of drips.
2. Isolate water supply and release water pressure by operating faucet lever.
3. Disconnect tubing from the cartridge. Discard old cartridge.

4. Remove packaging from the new cartridge. Connect tubing to either end of the cartridge. Ensure flow arrow on cartridge is in direction of waterflow.

Replacement cartridge code for **X3** model: Puretec **IL149Q**

Replacement cartridge code for **X4** model: Puretec **IL150Q**

5. When replacing cartridge, ensure you reset the LED reminder light by removing/replacing the battery from the rubber seat. Please refer to page 6 for a detailed diagram.
6. Restore water supply.
7. Check for leaks, rectify any, before leaving the unit.

After installing cartridges flush unit for 5 - 10 minutes.

Use Guidelines

- Do not allow exposure to temperatures below 0°C. Protect from freezing.
- Maximum operating temperature 38°C.
- Maximum flow rate 1.9 Lpm.
- This product must be installed in accordance with local plumbing regulations by a licensed plumber on the cold water line - mains only.
- Replacement Cartridges: See Cartridge Changeout section.
- This system requires regular replacement of the filter cartridge to maintain proper operation. Varying chlorine, sediment, or organic substance levels may affect replacement frequency.
- Be sure to change the filter cartridge at least every 9,500 litres or 6 - 12 months whichever ever occurs first; or whenever you detect a change in taste, odour, or decrease in flow.

Caution: Do not use with water that is microbiologically unsafe or of unknown quality without adequate disinfection before or after the system.

Figure 1 - System Diagram

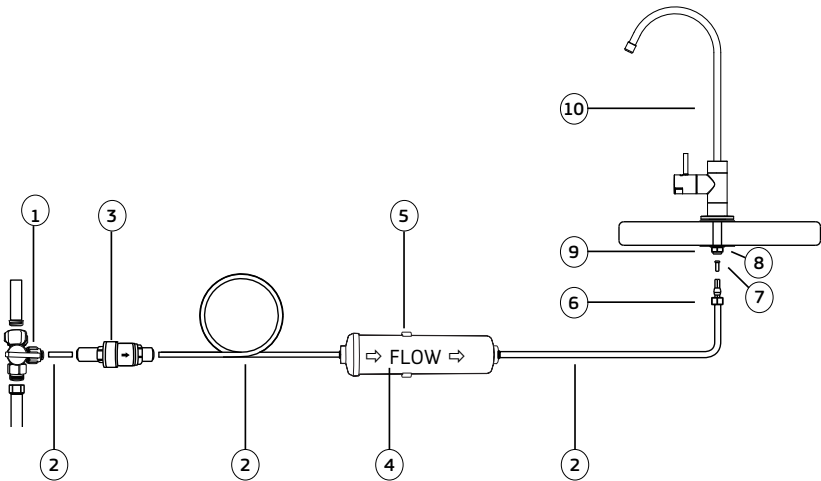

No.	DESCRIPTION
1	SmartTee™ ½”M x ½”F x ¼”T
2	Flexible White Tubing
3	Pressure Limiting Multivalve
4	Inline Filter Cartridge
5	Mounting Bracket

6	Tube, Nut and Ferrule
7	Tube Insert
8	Faucet Lock Nut and Washer
9	Black Plastic Washer
10	LED Faucet

Figure 2 - How to Use Quick Connect Fittings



1. Cut the tube square and push in to the tube stop. For metal tube remove burrs and chamfer tube end to prevent O-Ring seal being damaged.

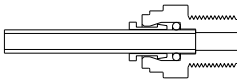

3. Tube is secured in position.

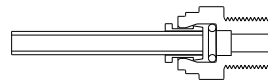

2. Fitting grips before it seals. Ensure tube is pushed in to tube stop.

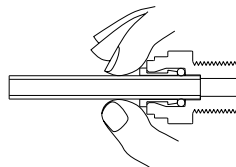

DISCONNECTION PROCEDURE

4. Push collet against body and slide tube out of fitting.

Figure 3 - SmartTee™ Quick Connect Fitting

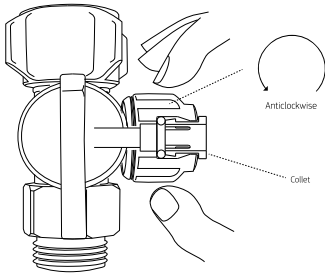

1. Turn the quick connect nut on the SmartTee™ anticlockwise to release the collet.

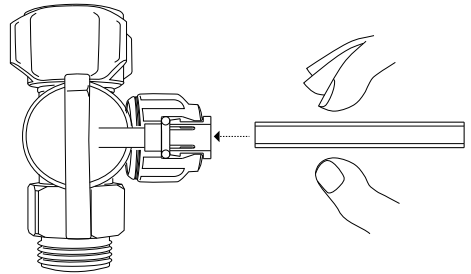

2. Cut the tube square and push into into the tube stop (inside the collet). For metal tube; remove burrs and chamfer tube end to prevent O-ring seal being damaged.

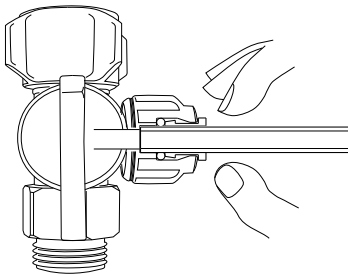

3. The fitting grips before it seals. Ensure the tube is pushed all the way into the tube stop.

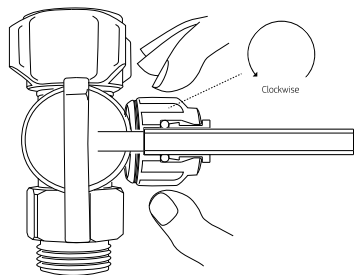

4. Once the tube is secured in position, turn the quick connect nut clockwise to secure.

Note: Hand tighten only. Do not overtighten.

DISCONNECTION PROCEDURE

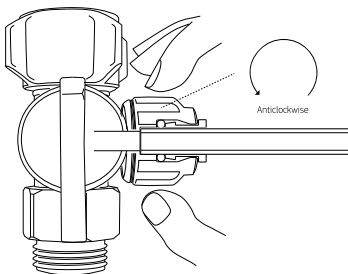

5. Turn the quick connect nut on the SmartTee™ anticlockwise to release the collet.

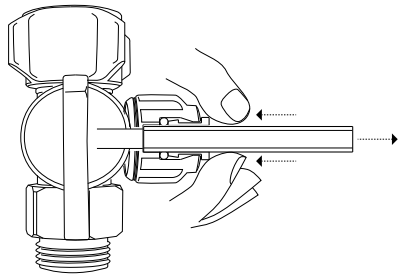

6. Push the collet against the quick connect nut and slide tube out of fitting.

Figure 4 - Battery Installation - LED Reminder Light

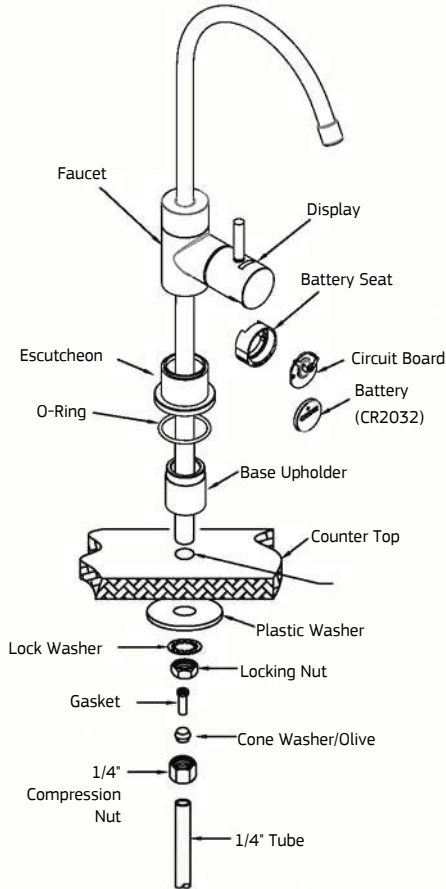

Important note: Battery must be replaced when changing cartridges.

1. Remove the black battery seat from the faucet lever handle (see Figure 3).
2. Install battery into the battery seat, positive side up.

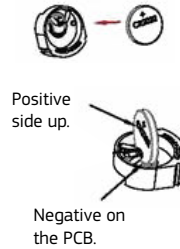

Note: Red light flashes twice and then followed by the blue light.



3. Reinstall battery seat assembly into the faucet lever.



4. Blue light flashes during normal operation.



5. Red light flashes indicates your cartridges are due to be changed (usage has exceeded 3,000 minutes or 12 months). **Please change the battery when changing the cartridges.**

WARNING!

This product contains a button battery. Accidental ingestion may occur and can be fatal. Please keep out of reach from infants. If you suspect an accidental ingestion please contact emergency services.

WARRANTY

Any claim under this warranty must be made within 10 years of the date of purchase of the product. This product is warranted to be free of defect of material and workmanship for 10 years from date of purchase. Warranty is 1 year parts and labour plus 9 years parts only. Excludes cartridges.

Puretec is renowned for its quality and after-sales support so if you have any issues please call 1300 140 140 (AU) or 0800 130 140 (NZ). To make a warranty claim, contact us directly or the place of original purchase. All costs relating to a warranty claim must be approved by Puretec prior to any work being carried out

Puretec will pay your reasonable, direct expenses of claiming under this warranty. You may submit details and proof of your expense claim to place of purchase for consideration.

The warranty only applies if the product was used and/or installed in accordance with the user guide and/or installation instructions. This warranty is given in lieu of all other express or implied warranties and manufacturer shall in no circumstance be held liable for damages consequential or otherwise or delays caused or faulty manufacturing except as excluded by law.

Applicable to all above, is that the warranties need to be approved by Puretec to ensure product was not incorrectly used, installed or claimed. False and incorrect claims will be pursued at Puretec's discretion, including chargeable inspection and labour costs incurred.

WARRANTY/AUSTRALIA

This warranty is given by Puretec Pty Ltd, ABN 44 164 806 688, 37-43 Brodie Road, Lonsdale SA 5160, telephone no. 1300 140 140 and email at sales@puretec.com.au.

This warranty is provided in addition to other rights and remedies you have under law: Our goods come with guarantees which cannot be excluded under the Australian Consumer Law. You are entitled to replacement or refund for a major failure and to compensation for other reasonably foreseeable loss or damage. You are also entitled to have the goods repaired or replaced if the goods fail to be of acceptable quality and the failure does not amount to a major failure.

WARRANTY/NEW ZEALAND

This warranty is given by Puretec NZ LP, Reg. No 50081773, PO Box 875 Cambridge 3450 NZ, telephone no. 0800 130 140 and email at sales@puretec.co.nz.

This warranty is provided in addition to other rights and remedies you have under law: Our goods come with guarantees which cannot be excluded under the Consumer Guarantees Act. You are entitled to replacement or refund for a major failure and to compensation for other reasonably foreseeable loss or damage. You are also entitled to have the goods repaired or replaced if the goods fail to be of acceptable quality and the failure does not amount to a major failure.

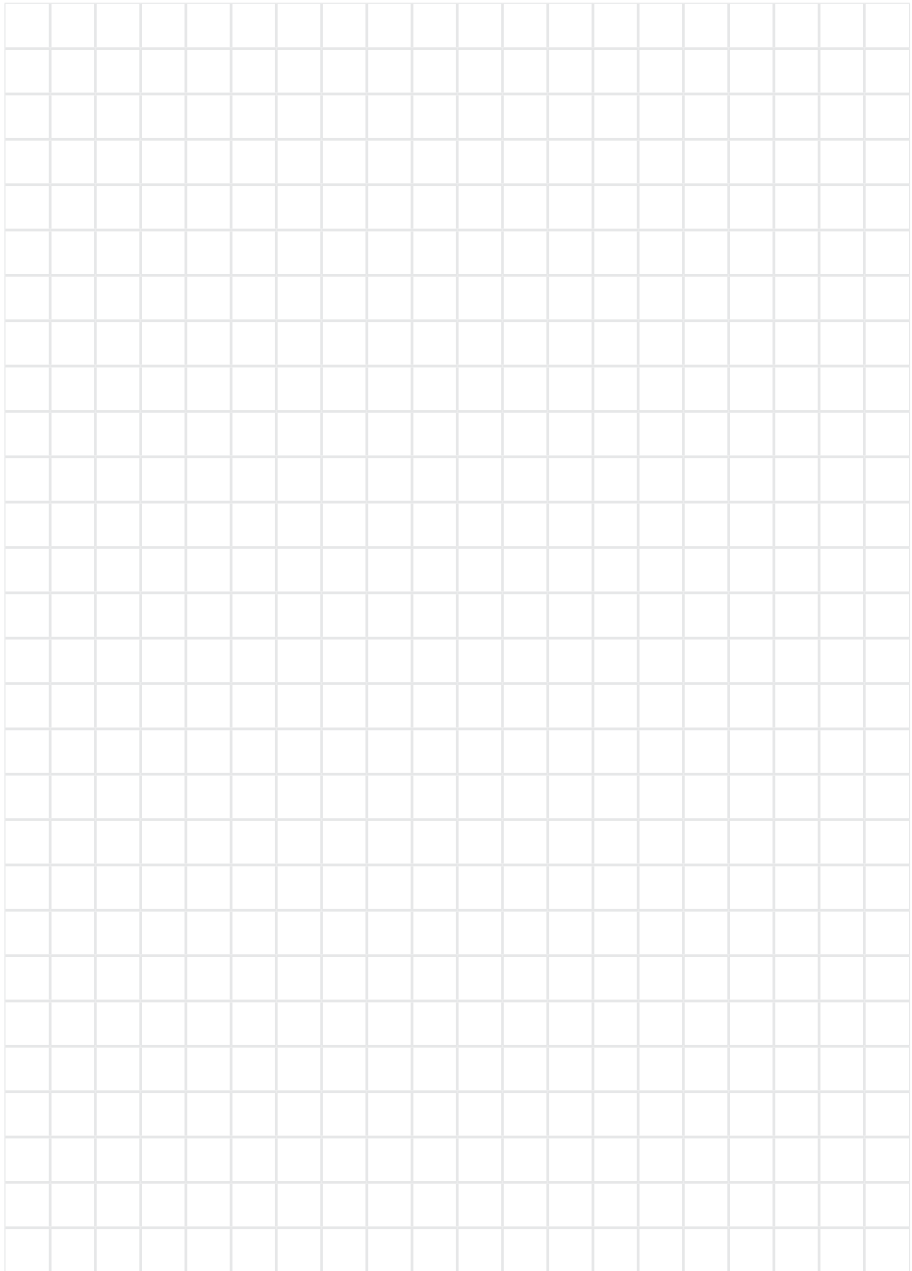

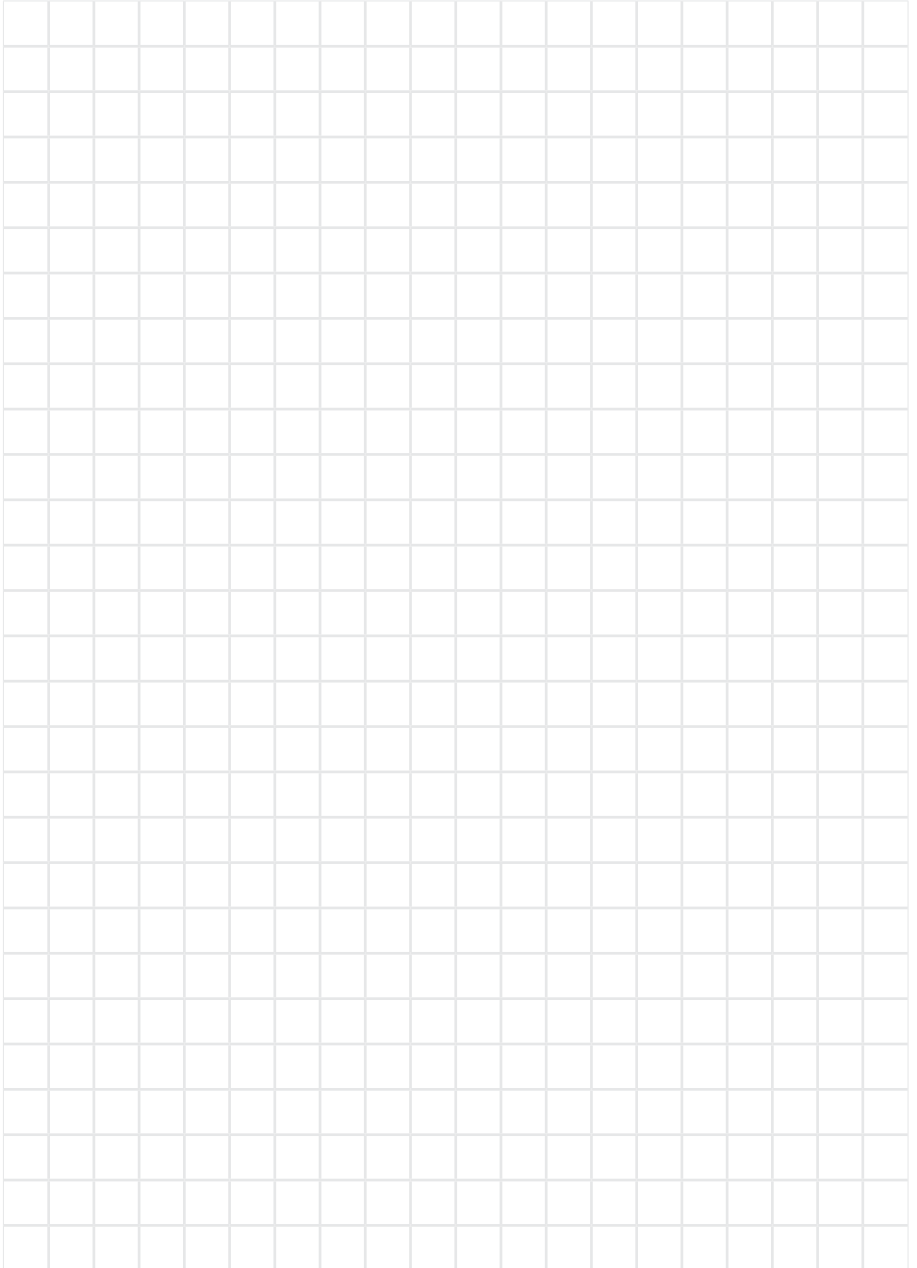



JUL2023

AUSTRALIA

P 1300 140 140

E sales@puretec.com.au

W puretec.com.au

NEW ZEALAND

P 0800 130 140

E sales@puretec.co.nz

W puretec.co.nz