



ONGA®

400 SERIES

HI-FLO CENTRIFUGAL PUMPS

High head water transfer, circulation duty
for hydroponic greenhouses, tank filling



Should the installer or owner be unfamiliar with the correct installation or operation of this type of equipment, contact the distributor or manufacturer for correct advice before proceeding with installation or operation of the product

RELAX - YOU' VE BOUGHT AN ONGA...

Congratulations on your decision to purchase an Onga product. Onga is one of the best known brands in its field, with a proud local and International reputation.

Onga is a brand for reliability, value for money and technological innovation.
So why does Onga lead its field? Here's a few simple reasons:

1. Continual Product Improvement

We employ the best engineers both in Australia and around the world to develop new and better ways to take water further.

2. Operational Excellence

There is only one standard that we set ourselves for both product quality and the quality of our service. That standard is excellence... to have no-one better than us at what we do... nothing short of that is acceptable.

3. A Fair Price

Onga products are neither the cheapest nor the most expensive in their field. Our products do, on the other hand, always represent very good value for money - they always have and they always will.

4. Our Team of Dealers

The hand picked authorised Onga dealer network throughout Australia and worldwide are second to none. We invest considerable time and resources training and supporting them through the Onga Training Academy.

You'll find an Onga product wherever people need to move water in 3 broad markets covering:



Residential

Technologically advanced solutions for moving and treating water in the Home, Garden and Pool.



Agricultural

Innovative Stock & Crop water management solutions for Primary Industries.



Process

Water movement products for building services, emergency services and original equipment manufactures

IMPORTANT!

The operator must be provided with this owner's manual. This must be read before operation and followed during operation.

These instructions are a guide only. Users not familiar with pumping equipment should seek advice from people with experience in pump installation.

Technical Data

Model	Part Number	Description	kW
413	341300	413 Medium Head Pump	0.37
414	341400	414 Medium Head Pump	0.37
415	341500	415 Medium Head Pump	0.75
416	341600	416 High Head Pump	0.37
417	341700	417 High Head Pump	0.75

Voltage	230V / 1 Phase
Suction / Discharge	1”BSPM / 1”BSPM (413, 416, 417) 1¼”BSPM / 1¼”BSPM (414, 415)
IP Rating	IP55
Motor Frequency	50Hz
Maximum Working Pressure	145kPa (413) 160kPa (414) 220kPa (415) 190kPa (416) 260kPa (417)
Maximum Fluid Temperature	70°C
Maximum Ambient Temperature	55°C

READ AND FOLLOW SAFETY INSTRUCTIONS!



This is the safety alert symbol. When you see this symbol on your pump or in this manual, look for one of the following signal words and be alert to the potential for personal injury:

DANGER

DANGER warns about hazards that **will** cause serious personal injury, death or major property damage if ignored.

WARNING

WARNING warns about hazards that **can** cause serious personal injury, death or major property damage if ignored.

CAUTION

CAUTION warns about hazards that **will** or **can** cause minor personal injury or property damage if ignored.

The label **NOTICE** indicates special instructions which are important but not related to hazards.

Carefully read and follow all safety instructions in this manual.

Electrical Safety



 **Wire motor for correct voltage. See 'Electrical' section of this manual and motor label.**

 **Ground motor before connecting to power supply.**

 **Meet National or local electrical code for all wiring.**

CAUTION

Do not touch an operating motor. Modern motors are designed to operate at high temperatures. To avoid burns when servicing pump, allow it to cool for at least 20 minutes after shut-down before handling.

General Safety

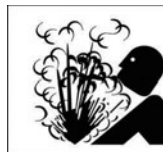

 **WARNING**
Hazardous pressure!
Do not run pump against closed discharge.
Release all pressure on system before working on any component.

To avoid heat build-up, over pressure hazard and possible injury, do not use in a pressure tank (domestic water) system. Do not use as a booster pump; pressurised suction may cause pump body to explode.

Do not allow pump or piping system to freeze. Freezing can damage pump and pipe, may lead to injury from equipment failure and will void warranty.

Pump water only with this pump.

Periodically inspect pump and system components. Wear safety glasses at all times when working on pumps.

INSTALLATION

a) Preparation for operation

Read these instruction first

Inspect your pump for shipping damage. Report any damage to your Onga dealer. Make sure the suction piping is free of air leaks and is laid so that it rises evenly from water source to pump. This makes priming easier and avoids airlock.

b) Pump Protection

Warranty of this pump is void unless it is operated in accordance with this owner's manual. The pump should be housed in a weather proof, well ventilated enclosure, to protect from the weather, flooding, chemicals, dust, vermin, insects etc.

c) Pump Mounting

The pump must be mounted on a solid, level, vibration free surface. Moulded pumps can be damaged by connected piping. Pipe should be supported so the pump casing is not strained by the pipe weight or misalignment.

d) Suction

To maintain optimum performance from your pump, the suction pipe should be:

- Kept to the shortest length possible - place the pump as close to the water source as possible.
- Re-enforced crush resistant (non-collapsible) hose or pipe.
- All fittings should be air tight.
- Pipes should be equal to or larger than the diameter of the suction/inlet port.
- If footvalve is being used it must be completely submerged.

CAUTION

This appliance is not intended for use by young children or infirm persons without supervision. Children should be supervised at all times when near this appliance.

Reduction of Capacity with Centrifugal Pump Suction

Total Suction Head		Percentage of Rated Capacity
Feet	Metres	
10	3.0	80%
15	4.6	70%
20	6.1	57%

Please note. Reduction of capacity affects both flow and pressure.

INSTALLATION (continued)

e) Discharge

The length and diameter of the discharge hoses or pipe will effect the pressure and flow rate at which your pump operates. Pressure ratings of all components must exceed the maximum pressure of the pump by an appropriate safety factor.

f) Valves

Onga recommend the use of a shut off valve in the discharge pipe to assist when maintenance is required. Closed loop systems or applications where the pump is installed vertically higher than the water source will require an additional check valve or footvalve.

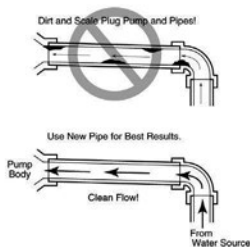

Figure 1 - No Dirt or Scale in Suction Pipe

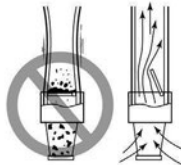

Figure 2 - Foot Valve Must Work Freely

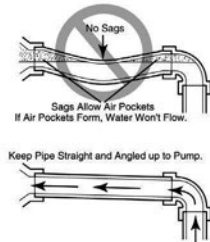

Figure 3 - No Air Pockets in Suction Pipe

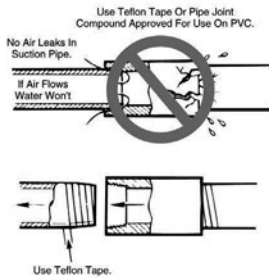

Figure 4 - Suction Pipe Must Not Leak

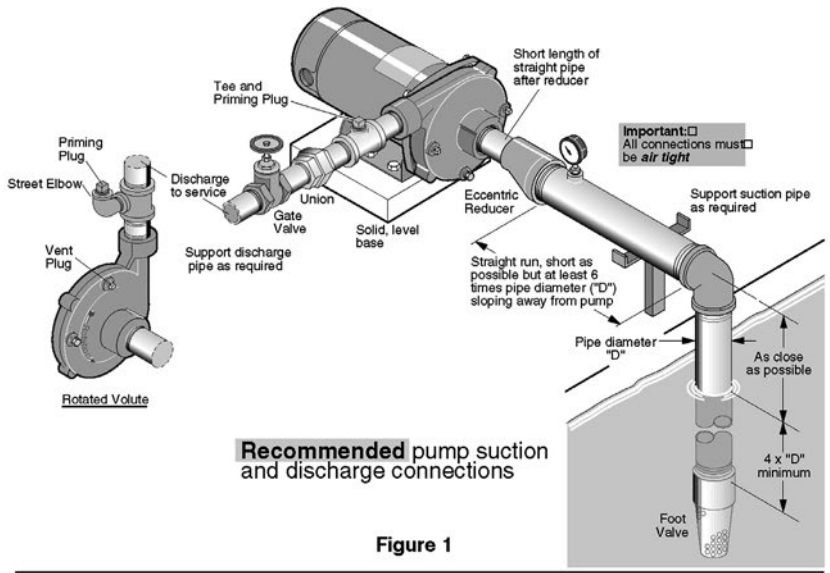

Figure 1

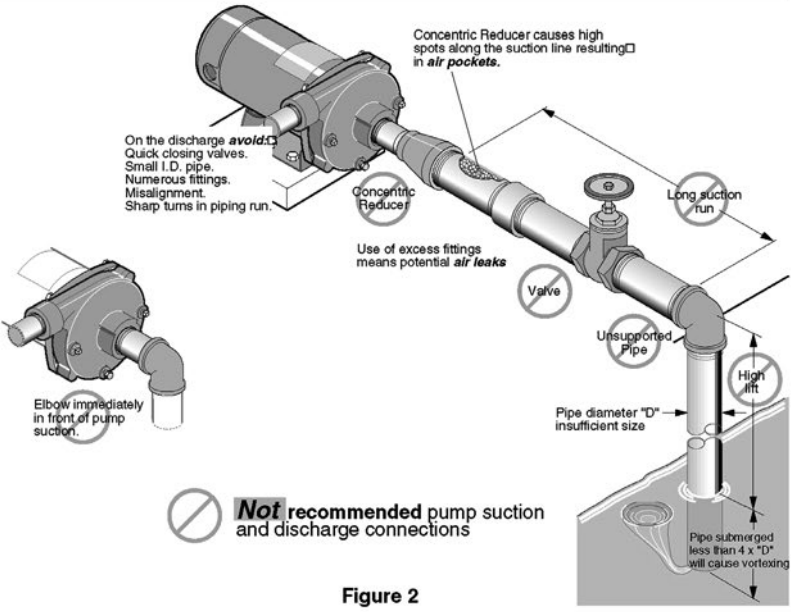

Figure 2

ELECTRICAL



- ⚠️ Disconnect power to motor before working on pump or motor.**
- ⚠️ Ground motor before connecting to electrical power supply. Failure to ground motor can cause severe or fatal electrical shock hazard.**
- ⚠️ Do not ground to a gas supply line.**
- ⚠️ To avoid dangerous or fatal electrical shock, turn OFF power to motor before working on electrical connections.**
- ⚠️ Supply voltage must be no lower than 6% or no higher than 10% of motor label voltage. Incorrect voltage can cause fire or damage motor and voids warranty. If in doubt consult a licensed electrician.**
- ⚠️ If possible, connect pump to a separate branch circuit with no other appliances on it.**
- ⚠️ An earth leakage or residual current protection device must be fitted to all installations, rated residual operating current not exceeding 30mA.**
- ⚠️ A voltage surge protector should be fitted as voltage spikes or incorrect voltage can cause fire or seriously damage the motor.**

Install, ground and maintain this pump in accordance with electrical code requirements. Consult your local building inspector for information about codes.

Provide a correctly fused Residual Current Device or Earth Leakage Device for protection while working on motor. Consult local or national electrical codes for switch requirements.

Disconnect power before servicing motor or pump. If the RCD or Earth Leakage device is out of sight of the pump, lock it open and tag it to prevent unexpected power application.

ELECTRICAL (continued)

Make ground connection to green grounding terminal under capacitor cover lid marked \perp and/or E.

230 volt single phase motors are supplied as standard with on winding thermal overload protection and are designed to plug directly into a 10 amp (GPO) domestic power supply to local electrical authority specifications.

If service is required to the power lead, it must be replaced with the appropriate specialised power lead assembly. Warranty is void if unauthorised modifications are made to any component.

Protect current carrying and grounding conductors from cuts, grease, heat, oil, and chemicals.

⚠ WARNING

Motor has automatic internal thermal overload protection. If motor has stopped for unknown reasons, thermal overload may restart motor unexpectedly, which could cause injury or property damage. Disconnect power before servicing motor.

If any of the preceding is confusing, consult a licensed electrician.

OPERATION

Priming the Pump (Suction lift installations)

NOTICE: ‘Priming’ refers to the pump expelling all air in the system and beginning to move water from its source out into the system. It does not refer only to pouring water into the pump (although pouring water in is usually the first step).

NOTICE: NEVER run pump dry. Running pump without water in it will damage seals and can melt impeller, diffuser and seal plate. To prevent damage, **fill pump with water before starting.**

1. Remove priming plug (located on top of the pump casing).
2. Make sure discharge valve(s) and any hoses on discharge side of the pump are open.
3. Fill pump and suction pipe with water.

OPERATION (continued)

4. Replace priming plug, using Teflon tape on thread; tighten plug.
NOTICE: If a priming tee and plug have been provided for a long horizontal run, be sure to fill suction pipe through this tee and replace plug. (Don't forget to Teflon tape the plug.)
5. Start pump: water should be produced in 10 minutes or less, the time depending on depth to water (suction lift not more than 6 metres) and length of horizontal run.

If no water is produced within 10 minutes, stop pump, release all pressure, remove priming plug, refill and try again.

WARNING

Hazardous pressure and risk of explosion and scalding. If pump is run continuously at no flow (that is, with discharge shut off or without priming), water may boil in pump and piping system. Under steam pressure, pipes may rupture, blow off fittings or blow out of pump ports and scald anyone near.

To prevent explosion, do the following:

- A. Ensure discharge (valve, hose nozzle, etc.) is open whenever pump is running.
- B. If pump fails to produce water when attempting to prime, release all pressure, drain pump and refill with cold water after every two attempts.
- C. When priming, monitor pump and piping temperature. If pump or piping begin to feel warm to the touch, shut off pump and allow system to cool. Release all pressure in system and refill pump and piping with cold water.

SERVICE & MAINTENANCE



This centrifugal pump requires little or no regular service other than reasonable care and periodic cleaning. Occasionally, however, a shaft seal may become damaged and must be replaced. The procedure as outlined below will enable you to replace the seal.

⚠ CAUTION Liquid may be HOT, release pressure before servicing.

NOTICE: The highly polished and lapped faces of the seal are easily damaged. Read instructions and handle the seal with care.

REMOVAL OF OLD SEAL

1. After unscrewing impeller, carefully remove rotating part of seal by prying up on sealing washer, using two screwdrivers (see Figure A). Use care not to scratch motor shaft.
2. Remove seal plate (baffle) from motor and place on flat surface, face down. Use a screwdriver to push ceramic seat out from seal cavity (see Figure B).

INSTALLATION OF FLOATING SEAL

(Figure C)

1. Clean polished surface of floating (ceramic) seat with clean cloth.
2. Turn seal plate over so seal cavity is up; clean cavity thoroughly.
3. Lubricate outside rubber surface of ceramic seat with silicone based lubricant, ensuring no lubricant gets on the polished ceramic wear face, and press firmly into seal cavity with finger pressure. If seat will not locate properly in this manner, place a cardboard washer over polished face of seal and press into seal cavity using a ½" 13mm socket or 13mm piece of standard pipe.

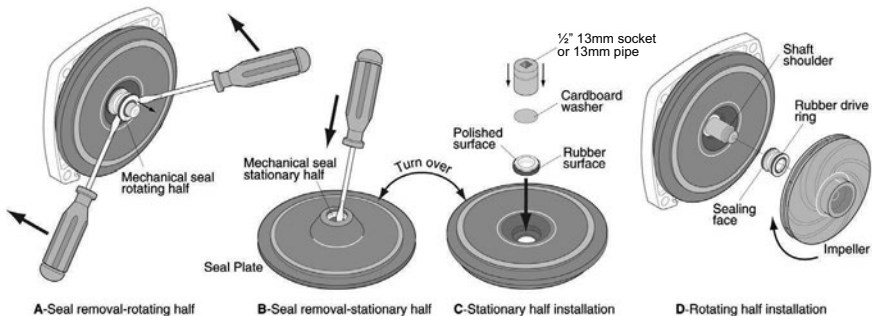

SERVICE & MAINTENANCE (continued)

4. **Dispose of cardboard washer.** If need ensure polished surface of seal seat is free of dirt and has not been damaged during insertion. Remove any excess lubricant that may have been dislodged during insertion and ensure that there is no lubricant on the polished face of the seal.

INSTALLATION OF ROTATING PART OF SEAL UNIT

(Figure D)

1. Clean face of sealing washer with clean cloth.
2. Reinstall seal plate using extreme caution not to hit ceramic portion of seal on motor shaft.
3. Inspect shaft to ensure that it is clean.
4. Lubricate outer face of rubber drive ring with silicone-based lubricant, ensuring no lubricant touches the polished face, and slide assembly on motor shaft (sealing/polished face first) until rubber drive ring hits shaft shoulder (ensure that the polished face does not hit the motor shaft).
5. Screw impeller on shaft until impeller hub hits shaft shoulder. This will automatically locate seal in place and move the sealing washer face up against the facing seat.

Should you have any difficulty replacing the seal unit please contact your local pump professional.

CAUTION

Liquid may be HOT, release pressure before servicing.

CAUTION

Pump should only be serviced by qualified personnel. Make sure to prime pump before operating. NEVER run pump dry!

CAUTION

If the supply cord is damaged, it must be replaced by the manufacturer or an authorised service agent.

Troubleshooting Guide

Symptom	Cause	Remedy
<p>Pump failure or reduced capacity or reduced discharge pressure.</p> <p><i>Thermal Overload tripping: The thermal overload is automatic and resets after the pump has cooled. If thermal continues to trip there is something wrong with the pump.</i></p>	<p>Suction leaks / lost prime</p>	<p>Pump must be primed; make sure that the pump casing is full of water. Refer priming instructions.</p> <p>Make sure there are no leaks in suction piping.</p> <p>Make sure suction pipe inlet is well below the water level to prevent pump from sucking air.</p> <p>Suction lift of 3 to 6 metres will reduce performance. Suction lift of more than 6 metres will prevent pumping and cause pump to lose prime. In either instance, move the pump closer (vertically) to water source. Ensure the suction pipe diameter is large enough.</p>
	<p>Clogged pipe / impeller, worn impeller.</p>	<p>Make sure that the impeller is not clogged. This should be checked by qualified personnel only.</p> <p>Impeller and diffuser may be worn. If so, check with your local Onga dealer or suitably qualified personnel.</p> <p>Pump may be trying to push too high a column of water. If so, a "higher head" pump is required.</p>
	<p>No power at outlet.</p>	<p>Use another electrical appliance that is known to work to check the power outlet.</p>
	<p>Blown fuse.</p>	<p>Check fuse and replace if necessary.</p>
	<p>Incorrectly sized pipe.</p>	<p>Check pipe work pressure losses and replace with larger diameter pipe if required.</p>
	<p>Motor burnt out due to voltage spike or flooded by water.</p>	<p>The motor may need replacing.</p>
	<p>Valves turned to the closed position.</p>	<p>Check the plumbing to ensure the valves are in the correct position for pumping on the suction and discharge.</p>
	<p>Air ingress to system.</p>	<p>Prime the pump. Check that there are no air leaks in the suction piping or fittings. Check that there are no leaks coming from beneath the pump.</p>

Troubleshooting Guide (Continued)

Symptom	Cause	Remedy
Pump running too slowly.	Low voltage.	Check voltage at motor terminals and at meter while pump is running – this check should be performed by a qualified electrician only. If voltage is low check for loose connections or consult your power company.
	Pump may be too hot.	Check line voltage; if less than 90% or more than 110% of rated voltage consult a licensed electrician. Increase ventilation. Reduce ambient temperature. Tighten any loose connections.
Pump leaking from between the casing and motor.	Casing bolts are not tightened sufficiently; Casing O’ring is worn; Mechanical seal requires replacing.	Switch off the power to the pump. Loosen the casing bolts. Check the alignment and condition of the casing o’ring before retightening the bolts. Replace the o’ring if leaking persists. Replace the mechanical seal.
No water.	Pump not running.	Check power supply.
	Gate valve closed.	Open gate valve.
Pump runs but no water.	Air leak in suction pipe.	Check suction pipe.
	The pump has not been filled with water.	
	Water has evaporated leaving the pump dry.	
	Foreign matter has clogged the impeller.	
Pump will not prime.	Foot valve leaking.	Check foot valve for seal, fix or replace if necessary.
	Air lock.	Check suction line for ‘humps’. Have your local pump professional prime the pump with an engine drive pump to score air from lines.
	Water source has been drawn down so that suction is above the water line.	Check suction is submerged.

Should problems persist, contact your nearest Onga service agent.

REPAIR PARTS LIST

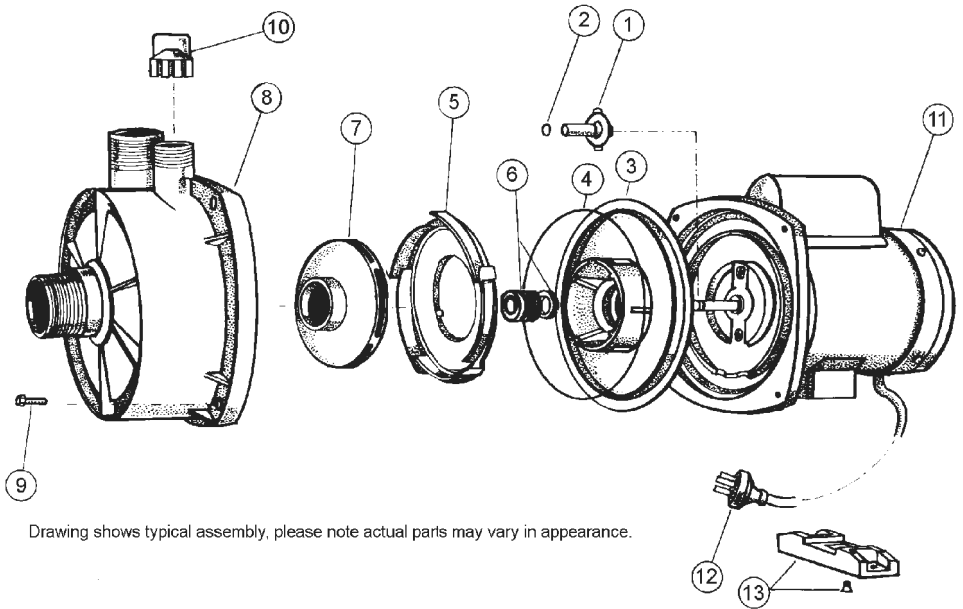

Drawing shows typical assembly, please note actual parts may vary in appearance.

Item	Description	Qty.
1	Shaft Sleeve & O'ring	1
2	O'ring - Shaft Sleeve	1
3	Seal Plate (Baffle)	1
4	O'ring - Casing	1
5	Diffuser	1
6	Mechanical Seal	1
7	Impeller	1
8	Casing	1
9	Screw - Casing	4
10	Priming Cap	1
11	Motor	1
12	Lead - Motor	1
13	Base & Screws Kit	1
	Nut - Casing (not shown)	4

IMPORTANT

Please attach your sales invoice/docket here as proof of purchase should warranty service be required.

Please do not return Warranty - Retain for your records.

Purchased From

Purchase Date..... Serial No..... Model No.....



1-21 Monash Drive,
Dandenong South, Vic 3175

Australia

National Customer Service: Phone: 1300 137 344
Fax: 1800 006 688
National Dealer Locator: Phone: 1800 664 266
Email: au.sales@pentair.com
Web: www.pentair.com.au

New Zealand

National Customer Service: Phone: 0800 654 112
Fax: 0800 806 642
National Dealer Locator: Phone: 0800 664 269
Email: nz.sales@pentair.com
Web: www.pentair.co.nz

International Australia/New Zealand

Phone: +61 3 9709 5800
Fax: +61 3 9709 5888

© Information contained here-in remains the property of Pentair Pty Ltd. Any reproduction, display, publication, modification or distribution is strictly prohibited without the prior written permission of Pentair Pty Ltd.

Disclaimer: Pentair reserves the right to change product specifications and products details. All product images are for reference purposes only and may not represent actual and/or current product.